

CUERDAS

**Cuerdas, hilos y cordeles
gomas elásticas y lanas de
colores**

CÓNICAS: MÉTODO JARDINERO

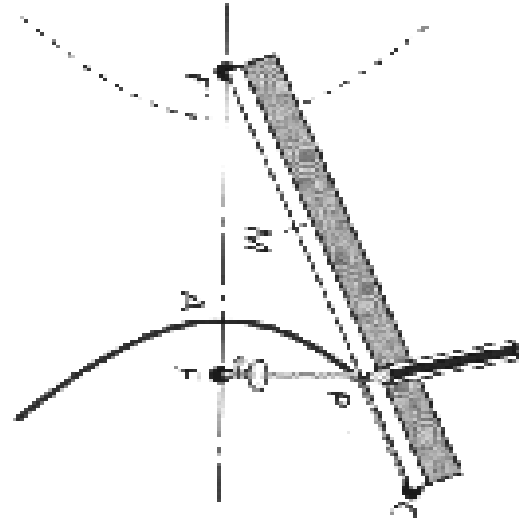
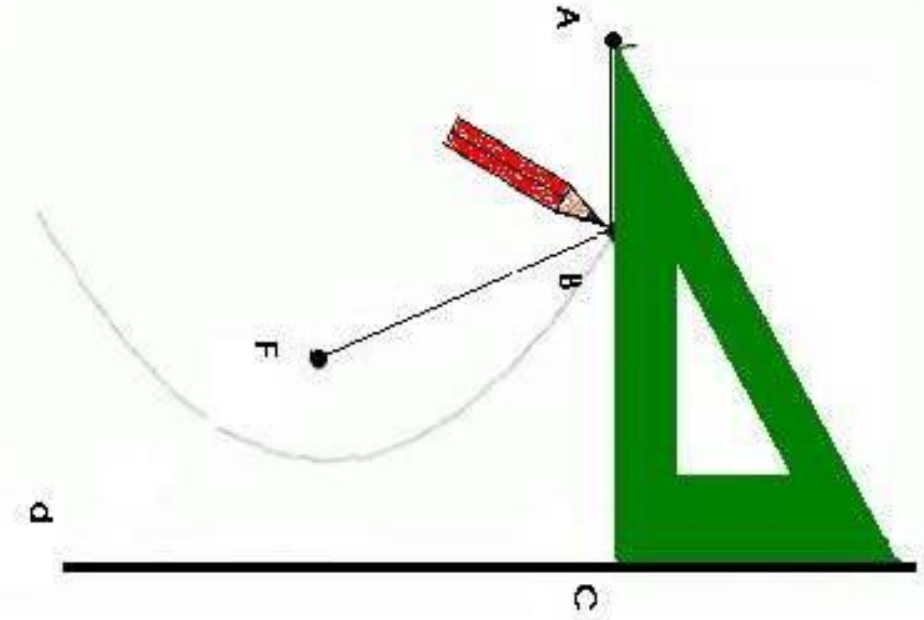
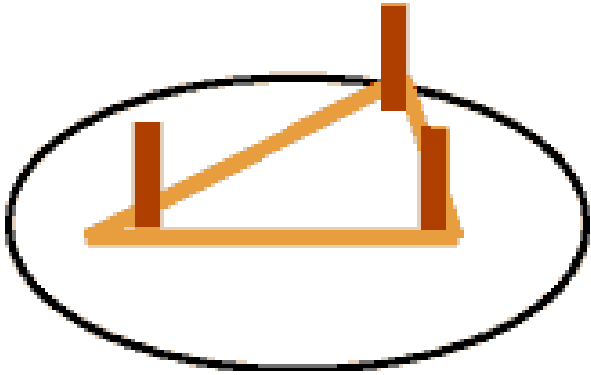
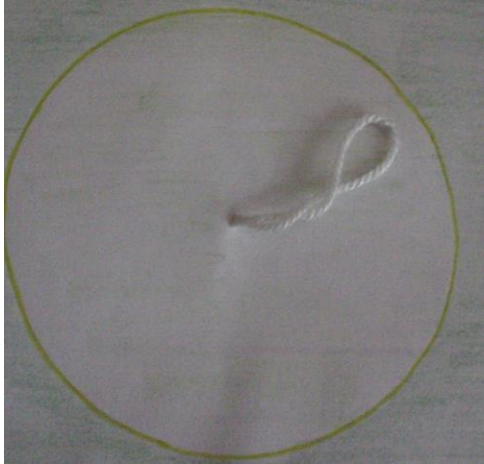

Más curvas con cuerdas

- Espiral de Arquímedes con carrete cilíndrico
- Espiral geométrica con carrete cónico

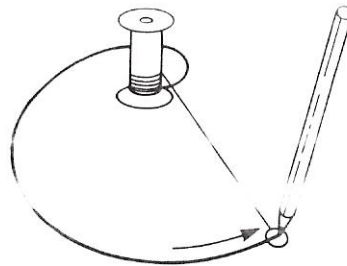

Superficies regladas

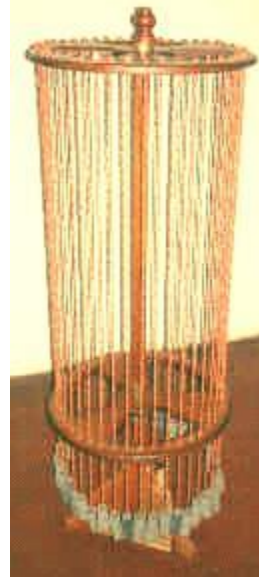

Probabilidad engañosa

- **Probabilidad lazos rotos-lazos enteros**

Presupuesto mínimo

- Gasolinera entre tres pueblos

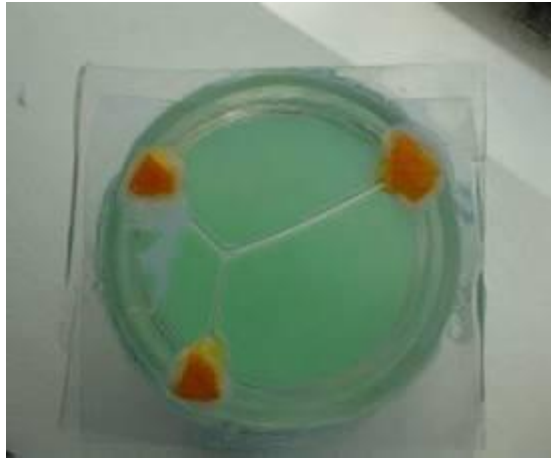

Teorema de euler

- figuras trazo continuo

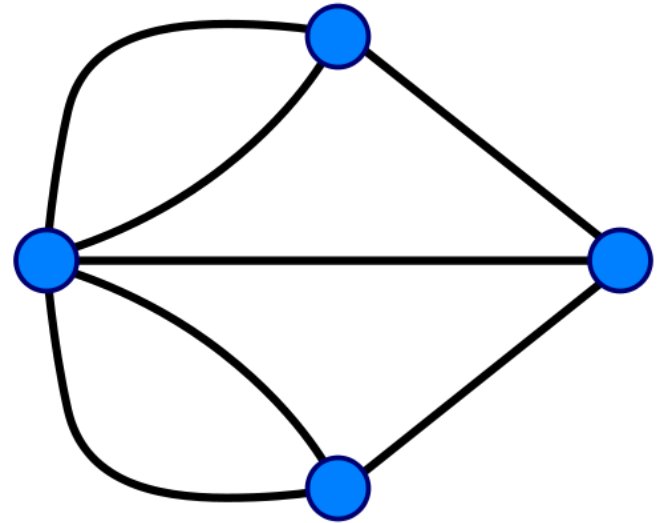
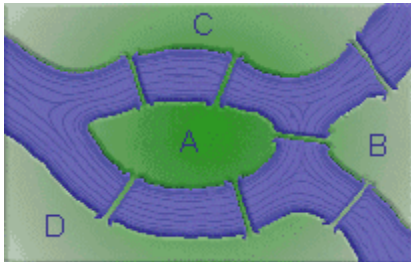

Triángulos isoperimétricos

- Elipse

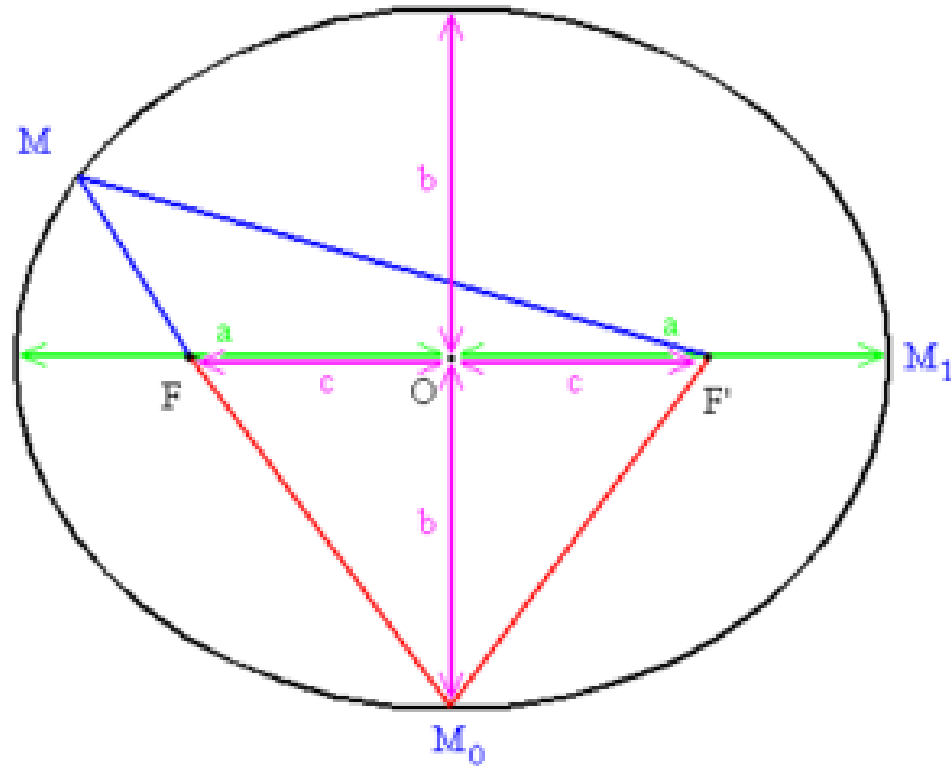

Rectángulos isoperimétricos

- **Cordel Emma**

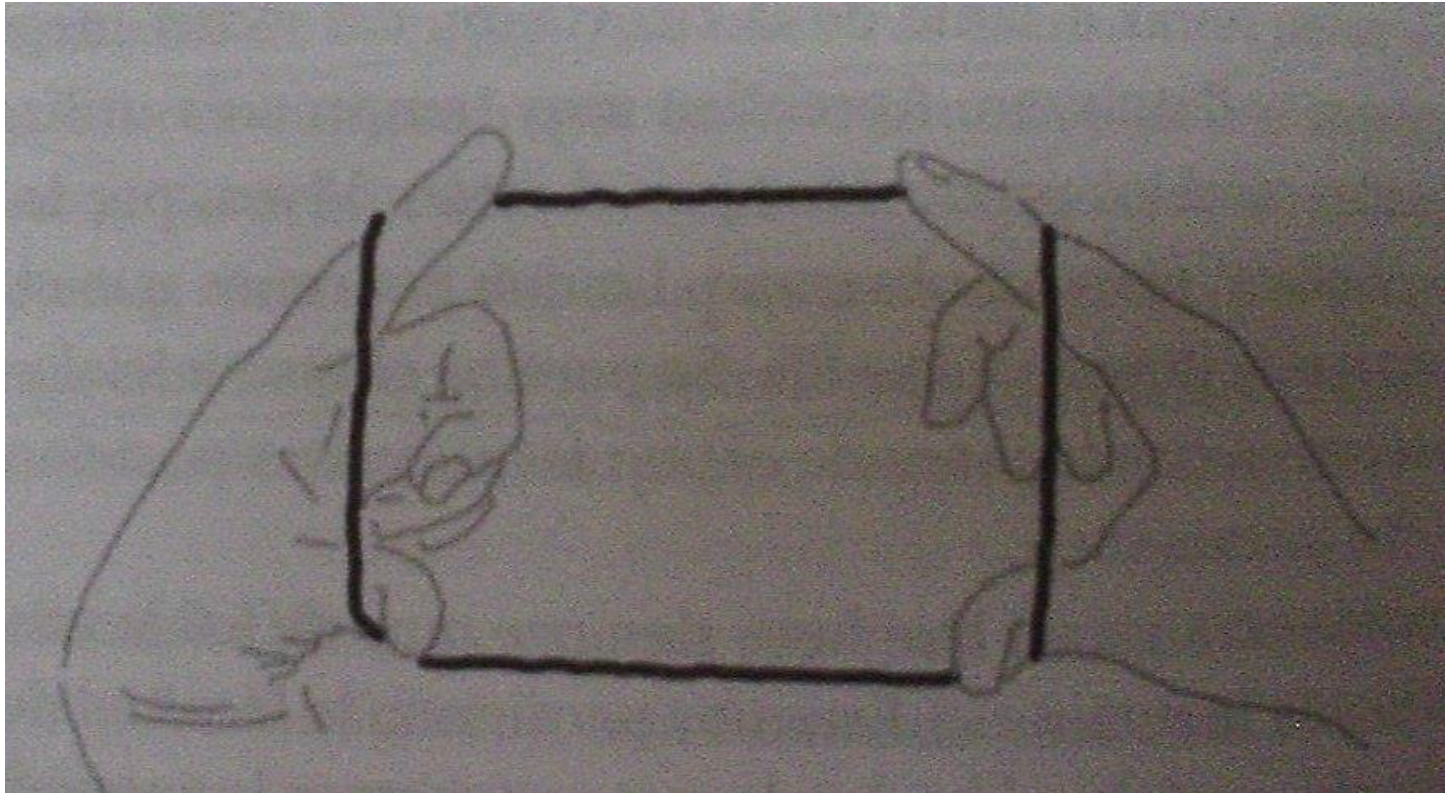

Gráfica base-altura rectángulos perímetro constante

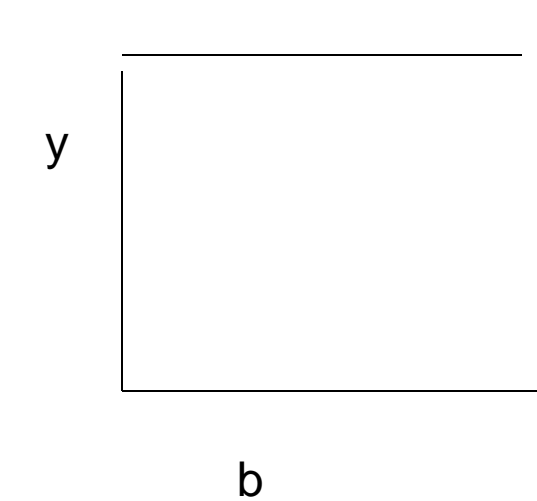

$$y+b=a$$

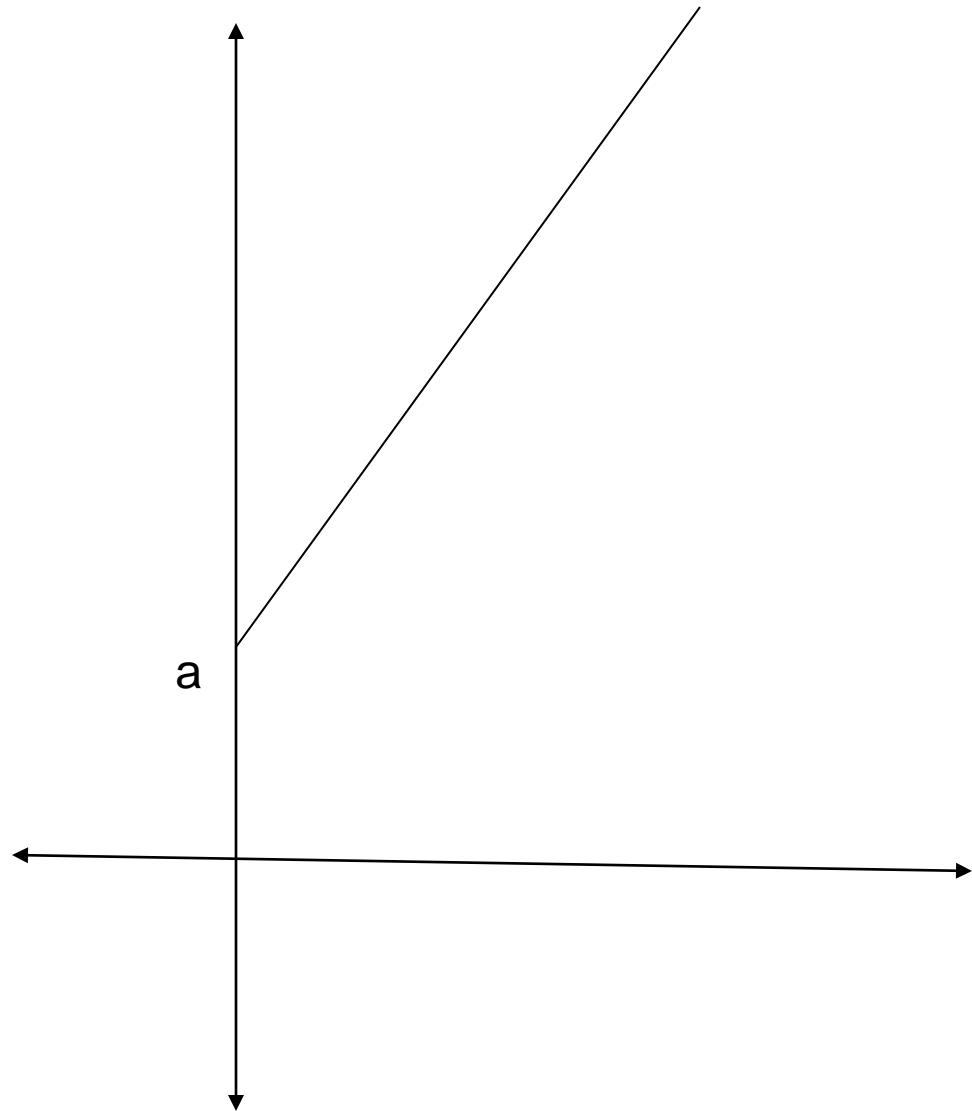

Isoperimetrico plano con cuerda y jabón

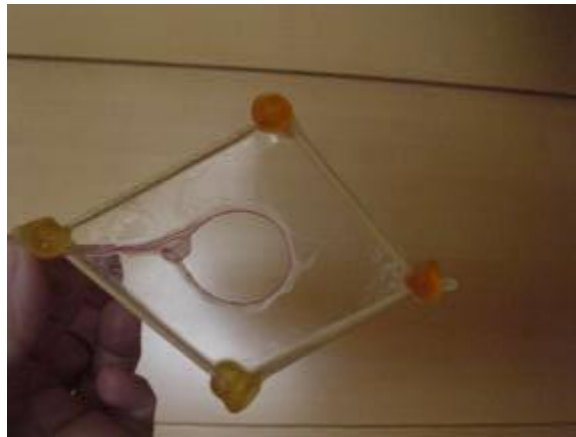

Aristas icosaedro Tres tarjetas

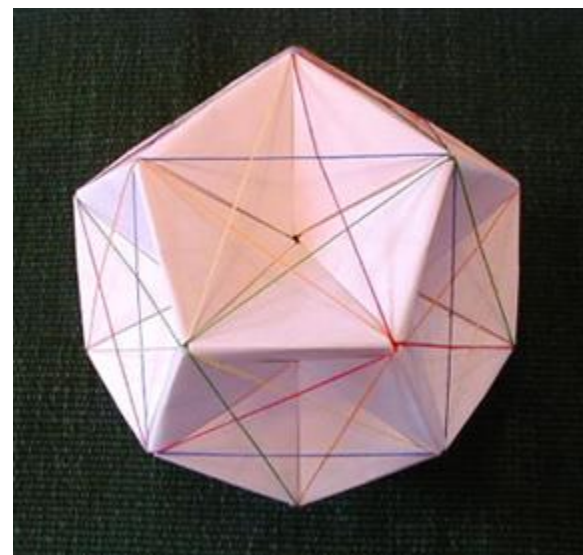
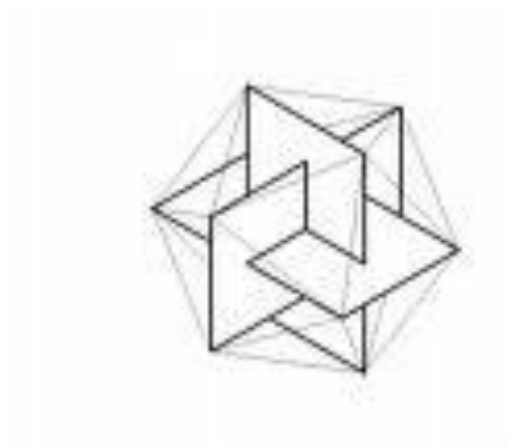

telarañas



encajes

rosetas, frisos, mosaicos



Confeccion de cuerdas

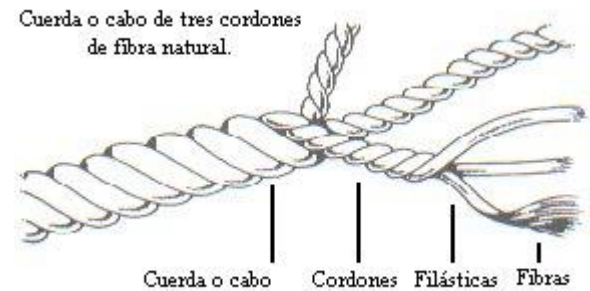

Nudos



=



?

Rompecabezas



Comba



Combinatoria

Teoría de cuerdas

